



Electrical Characteristics										
Frequency	Hz	50				60				
Voltage (series star)	V	380	400	415	440	415	440	460	480	
Rated power class H	kVA	150	150	150	125	150	170	180	180	
	kW	120	120	120	100	120	136	144	144	
Rated power class F	kVA	136	136	136	113	132	150	163	163	
	kW	109	109	109	90,4	106	120	130	130	
Regulation with DSR		±1% with any power factor and speed variations between -5% +30%								
Insulation class		H								
Execution		Brushless								
Stator winding		12 ends								
Rotor		with damping cage								
Efficiencies class H	4/4	%	93,1	93,2	92,9	92,7	94,3	94,8	94,9	95
(see graph. for details)	3/4	%	93,2	93,5	93,4	93,1	94,7	94,9	95	95,2
	2/4	%	91,9	92	92	91,8	93,5	93,6	93,7	93,8
	1/4	%	89,2	89	88,8	88,8	90,2	90,2	90,2	90
Reactances (f. l.cl. F)	Xd	%	265,9	240	223,0	165,3	267,6	269,8	261,3	240
	Xd'	%	16,4	14,8	13,7	10,2	16,5	16,6	16,1	14,8
	Xd''	%	6,9	6,2	5,8	4,3	6,9	7,0	6,8	6,2
	Xq	%	135,3	122,1	113,4	84,1	136,1	137,2	132,9	122,1
	Xq'	%	135,3	122,1	113,4	84,1	136,1	137,2	132,9	122,1
	Xq''	%	29,4	26,5	24,6	18,3	29,5	29,8	28,9	26,5
	X ₂	%	18,3	16,5	15,3	11,4	18,4	18,5	18,0	16,5
	X ₀	%	2,8	2,5	2,3	1,7	2,8	2,8	2,7	2,5
Short Circuit Ratio	Kcc		0,40	0,48	0,55	0,91	0,30	0,35	0,40	0,48
Time Constants	Td'	sec.	0,0401							
	Td''	sec.	0,0095							
	Tdo'	sec.	1,90							
	Tα	sec.	0,017							
Short Circuit Current Capacity		%	>300				>350			
Excitation at no load	Amp.		0,3	0,4	0,5	0,7	0,2	0,3	0,4	0,5
Excitation at full load	Amp.		2,3	2,4	2,5	2,7	2,1	2,3	2,4	2,6
Overload (long-term)		%	1 hour in a 6 hours period 110% rated load							
Overload per 20 sec.		%	300							
Stator Winding Resistance (20 °C)	Ω		0,015							
Rotor Winding Resistance (20 °C)	Ω		3,577							
Exciter Resistance (20 °C)	Ω		Rotor : 0,410				Stator : 15,28			
Heat dissipation at f.l.cl.H	W		8894	8755	9171	7875	7253	7460	7739	7579
Telephone Interference			THF < 2%				TIF < 40			
Radio interference			EN61000-6-3, EN61000-6-2. For others standards apply to factory							
Waveform Distors.(THD) at f. load	LL/LN %		1,7 / 1,8							
Waveform Distors.(THD) at no load	LL/LN %		2,3 / 2,4							
Mechanical characteristics										
Protection			IP 21 (other protection on request)							
DE bearing			6314.2RS							
NDE bearing			6311.2RS							
Weight of wound stator assembly	kg		168							
Weight of wound rotor assembly	kg		106							
Weight of complete generator	kg		481							
Maximun overspeed	rpm		2250							
Unbalanced magnetic pull at f.l.cl.F	kN/mm		5,6							
Cooling air requirement	m ³ /min		19,3				23			
Inertia Constant (H)	sec.		0,098				0,117			
Noise level at 1m/7m	dB(A)		79 / 65				83 / 69			

All technical data are to be considered as a reference and they can be modified without any notice

This document is a propriety of Mecc Alte S.p.a..All rights reserved.



50 Hz

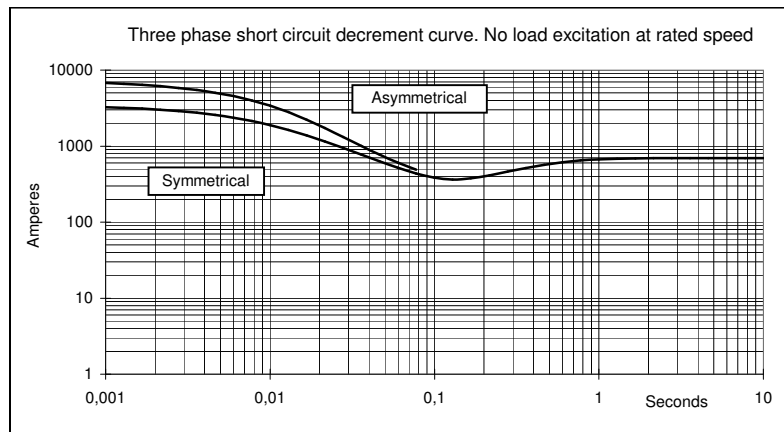
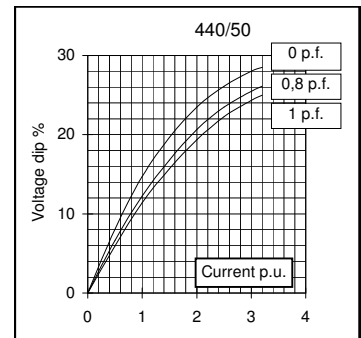
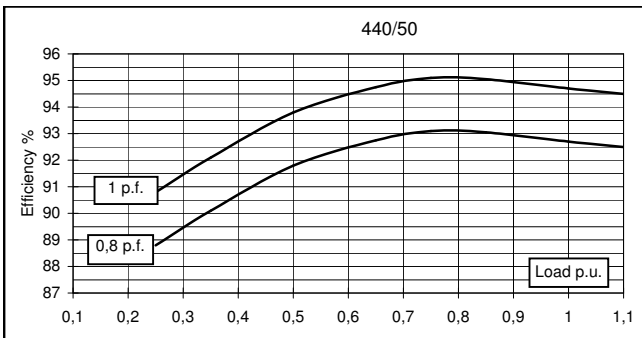
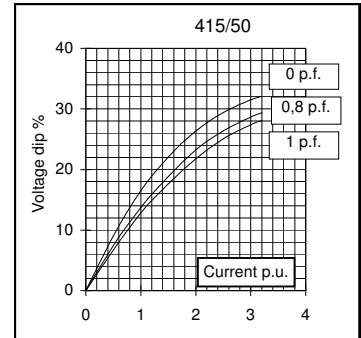
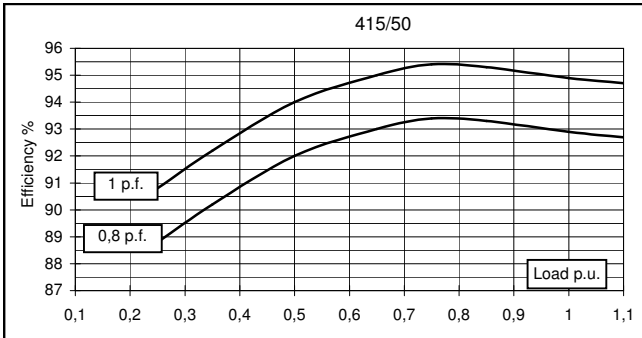
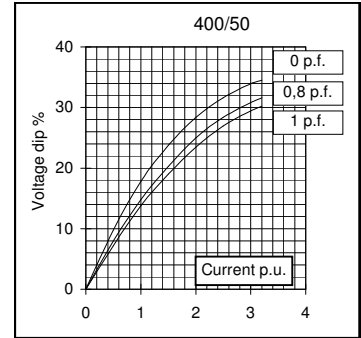
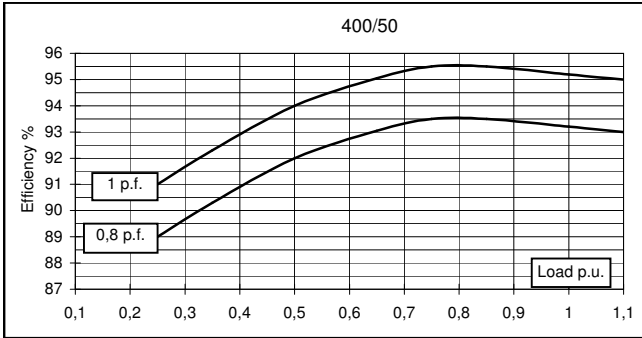
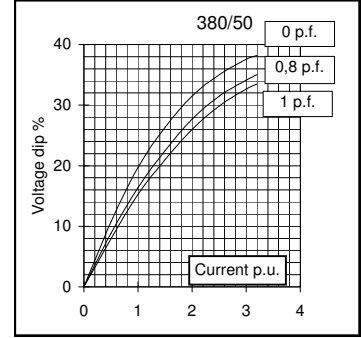
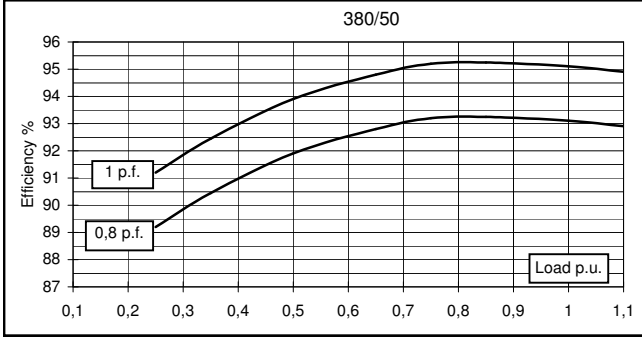



60 Hz

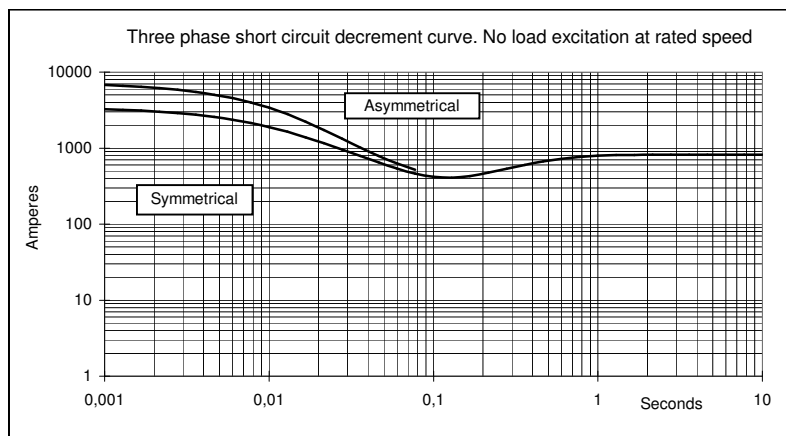
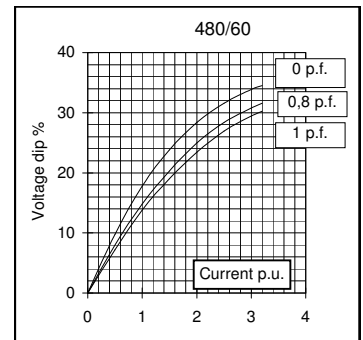
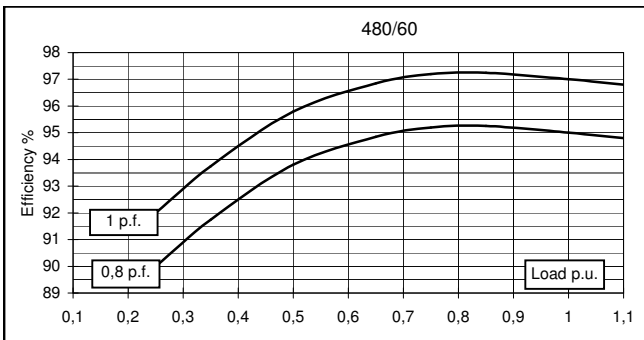
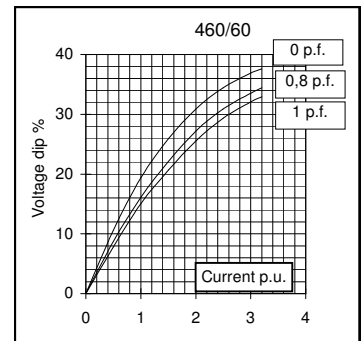
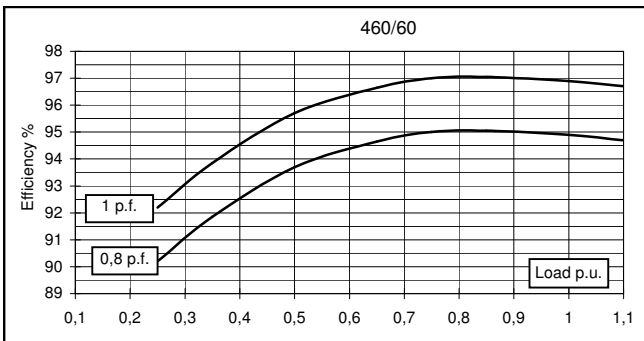
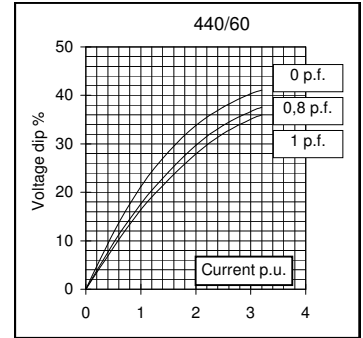
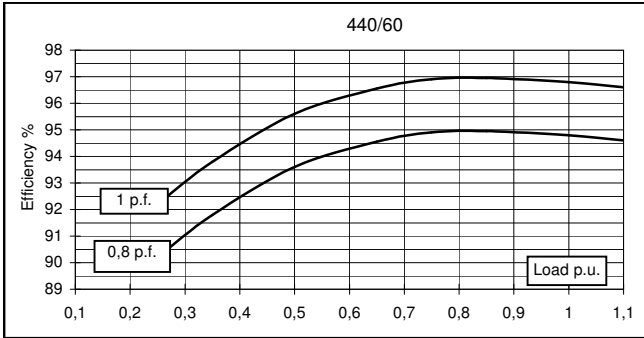
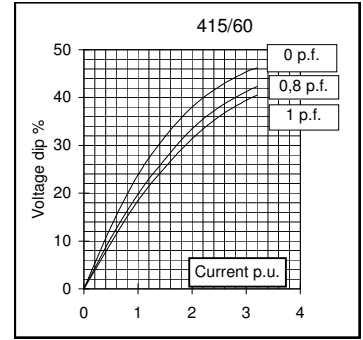
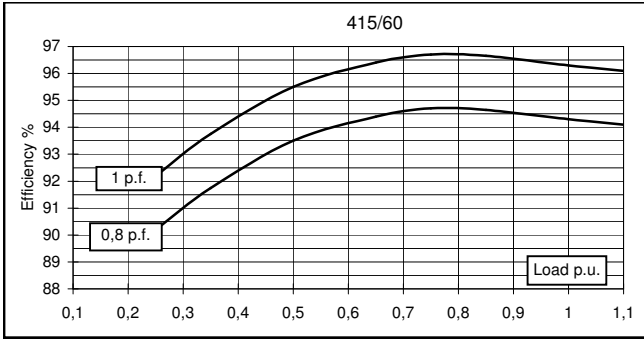

This document is a propriety of Mecc Alte S.p.a.. All rights reserved.

TWO BEARING MOMENTS OF INERTIA

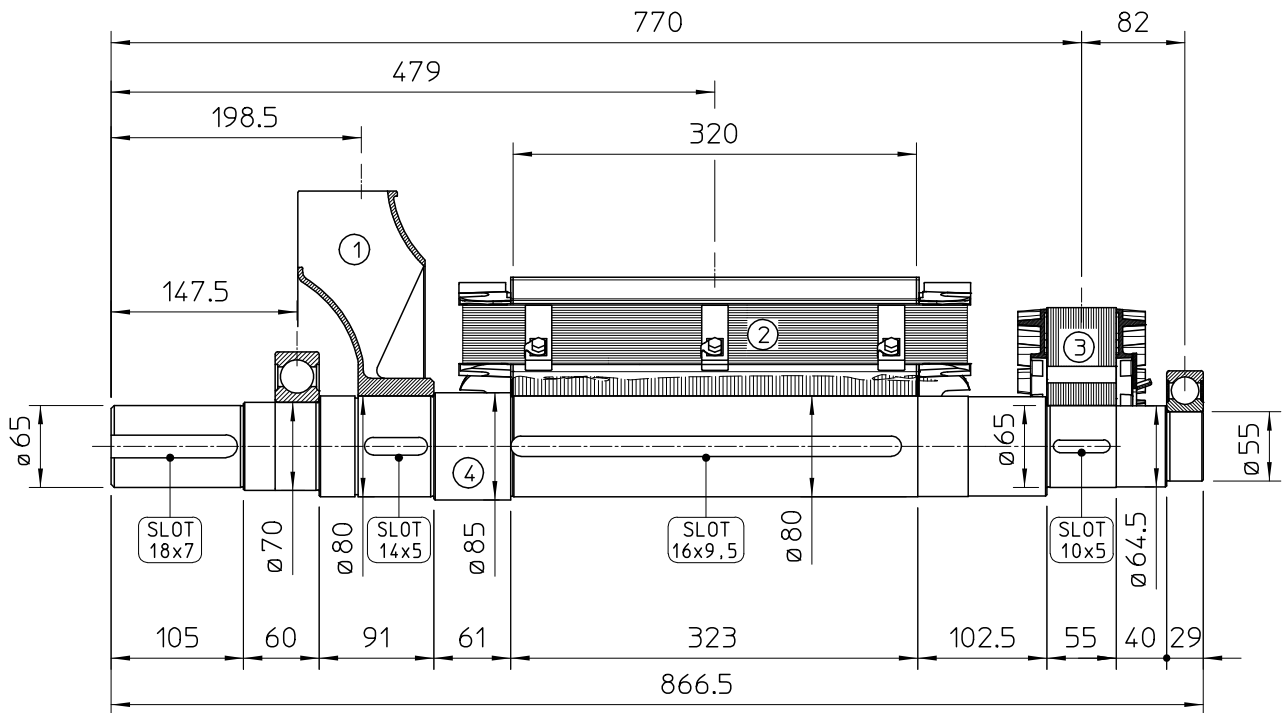

POS.	COMPONENT	WEIGHT (kg)	J (kgm ²)
1	FAN	3.6	0.0451
2	MAIN ROTOR	107.3	0.9647
3	EX. ROTOR	14.5	0.0874
4	SHAFT	29.6	0.0218
TOTAL		155	1.119

TWO BEARING DIMENSIONS

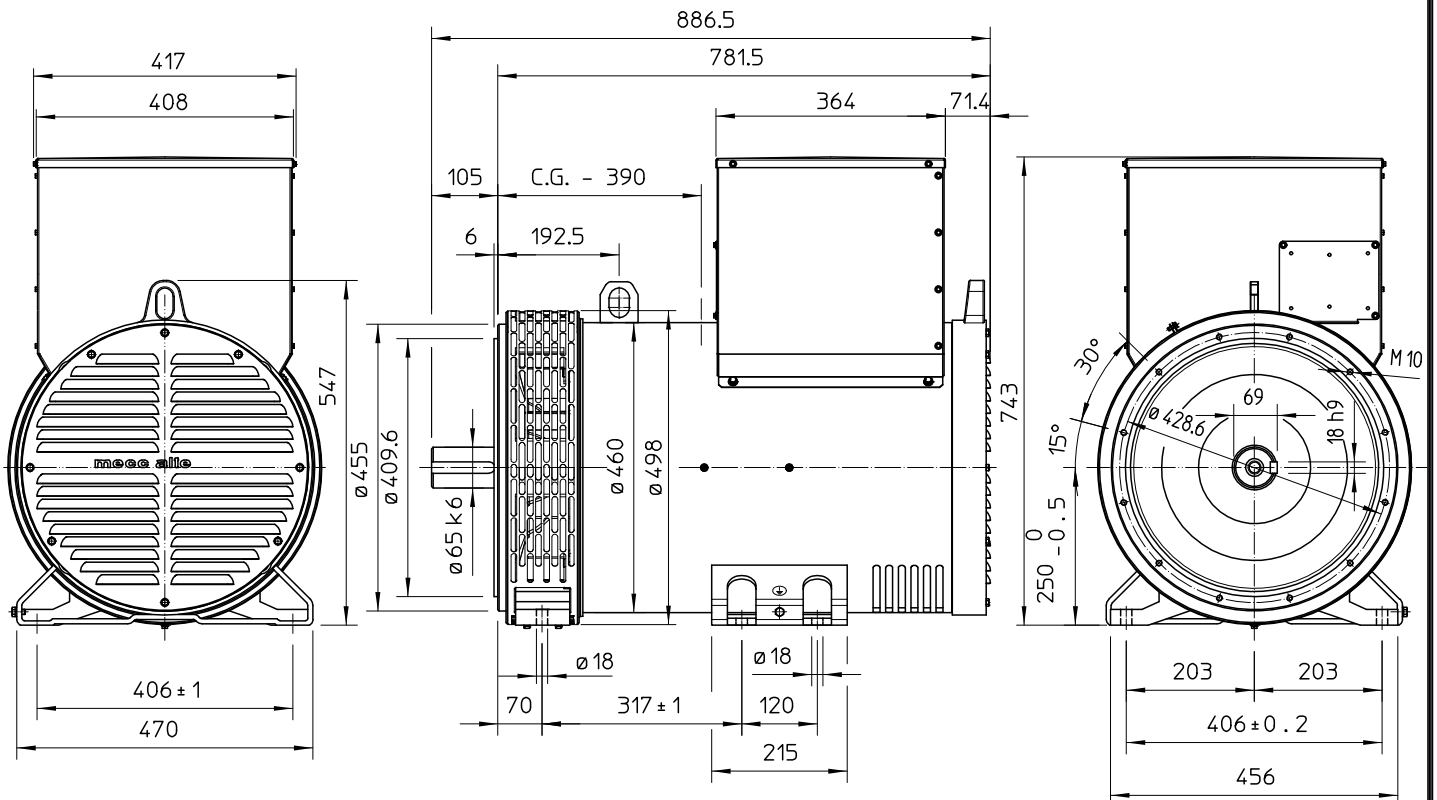

C.G.= GRAVITY CENTER

SINGLE BEARING MOMENTS OF INERTIA

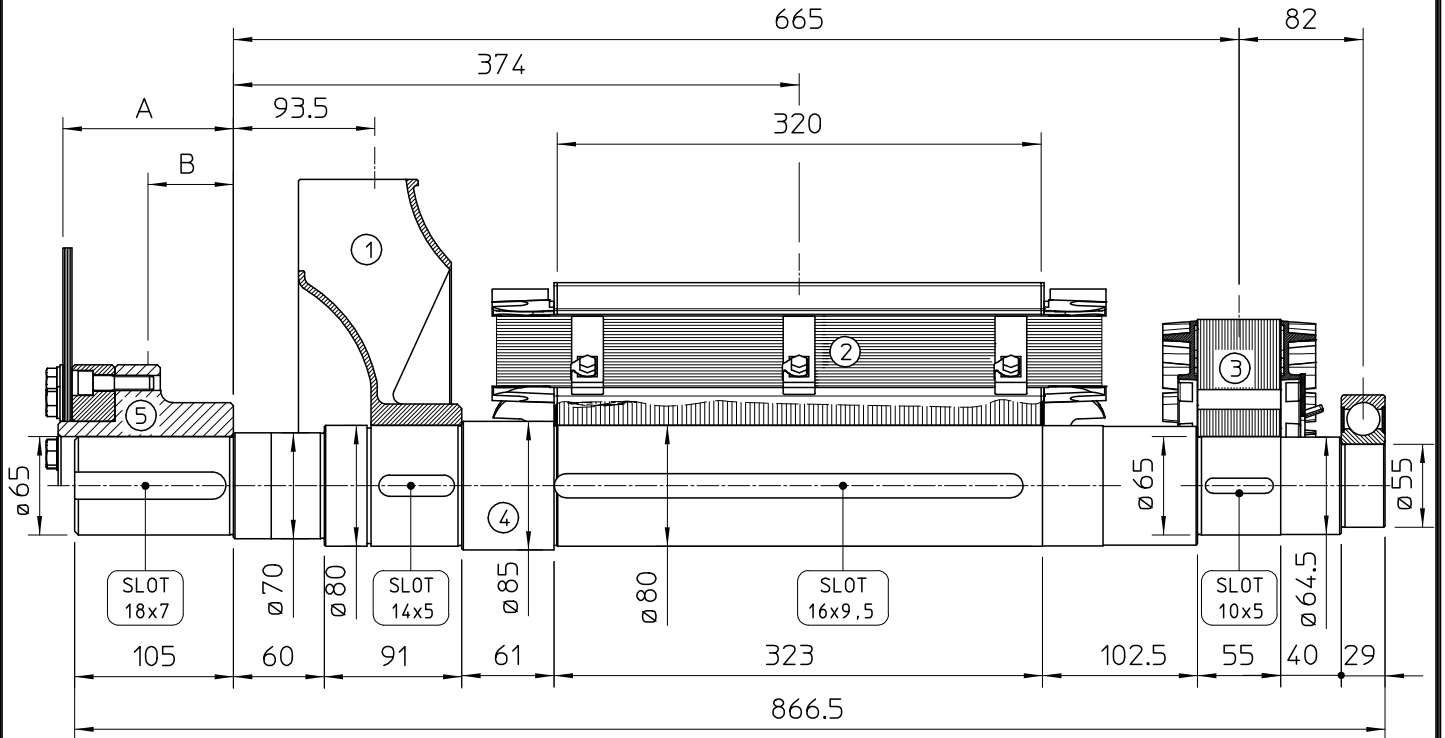

POS.	COMPONENT	WEIGHT (kg)	J (kgm ²)
1	FAN	3.6	0.0451
2	MAIN ROTOR	107.3	0.9647
3	EX. ROTOR	14.5	0.0874
4	SHAFT	29.6	0.0218
TOTAL		155	1.119

SAE N°	5		SHAFTS COUPLING FLEX PLATE	
	A	B	WEIGHT kg	J kgm ²
10	112.8	35.6	13.5	0.0770
11 1/2	98.6	71.5	12.4	0.0956
14	84.4	68.6	14.8	0.2360

SINGLE BEARING DIMENSIONS

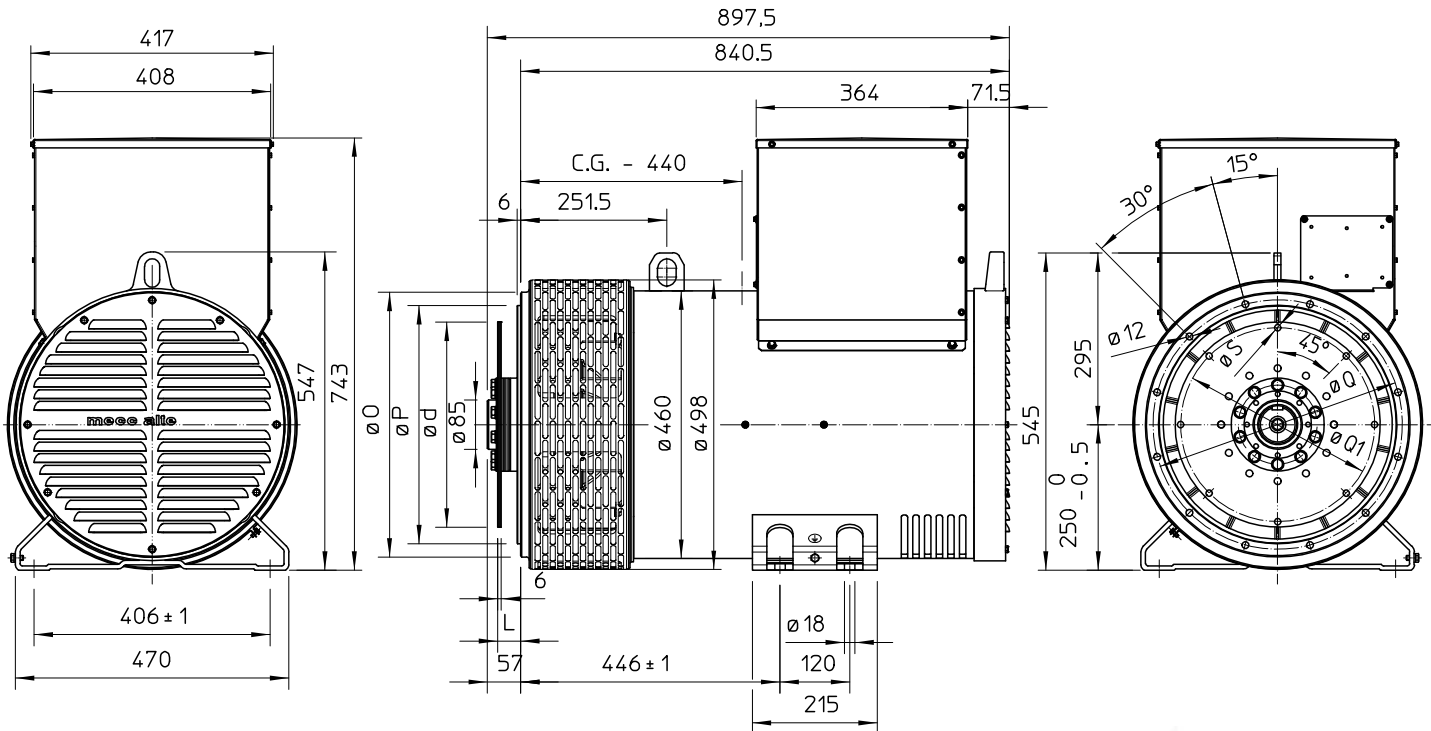

SAE N.	FLANGIA / FLANGE BRIDE / FLANSCH		
	O	P	Q
3	451	409.6	428.6
2	489	447.7	466.7
1	552	511.2	530.2

SAE N.	GIUNTI A DISCHI / DISC COUPLING DISQUE DE MONOPALIER / SCHEIBENKUPPLUNG			
	L	d	Q1	S
10	53.8	314.32	295.27	11
11 1/2	39.6	352.42	333.37	11
14	25.4	466.72	438.15	14

RAD Diesel

021-58437

C.G.= GRAVITY CENTER