

Electrical Characteristics										
Frequency	Hz	50				60				
Voltage (series star)	V	380	400	415	440	415	440	460	480	
Rated power class H	kVA	680	680	680	630	720	780	816	816	
	kW	544	544	544	504	576	624	653	653	
Rated power class F	kVA	630	630	630	585	665	720	756	756	
	kW	504	504	504	468	532	576	605	605	
Regulation with UVR6		±1% with any power factor and speed variations between -5% +30%								
Insulation class		H								
Execution		Brushless								
Stator winding		12 ends								
Rotor		with damping cage								
Efficiencies class H	4/4	%	93,9	94,3	94	93,7	95,1	95,6	95,7	95,8
(see graph. for details)	3/4	%	94,4	94,7	94,6	94,3	96,1	96,3	96,4	96,7
	2/4	%	93,7	93,8	93,8	93,6	95,2	95,3	95,4	95,5
	1/4	%	91,2	91	90,8	90,7	92	92,1	92,1	92
Reactances (f. l.cl. F)	Xd	%	249,5	225,2	209,2	172,4	265,8	256,2	245,2	225,2
	Xd'	%	27,0	24,4	22,7	18,7	28,8	27,8	26,6	24,4
	Xd''	%	16,4	14,8	13,7	11,3	17,5	16,8	16,1	14,8
	Xq	%	144,9	130,8	121,5	100,2	154,4	148,8	142,4	130,8
	Xq'	%	144,9	130,8	121,5	100,2	154,4	148,8	142,4	130,8
	Xq''	%	19,3	17,4	16,2	13,3	20,5	19,8	18,9	17,4
	X <sub>2</sub>	%	17,8	16,1	15,0	12,3	19,0	18,3	17,5	16,1
	X <sub>0</sub>	%	2,73	2,46	2,29	1,88	2,90	2,80	2,68	2,46
Short Circuit Ratio	Kcc		0,32	0,44	0,67	1,10	0,24	0,28	0,32	0,44
Time Constants	Td'	sec.	0,13							
	Td''	sec.	0,0157							
	Tdo'	sec.	2,91							
	Tα	sec.	0,0422							
Short Circuit Current Capacity		%	>300				>350			
Excitation at no load	Amp.		0,6	0,7	1	1,2	0,4	0,5	0,6	0,7
Excitation at full load	Amp.		4,3	4,4	4,7	4,9	3,5	3,6	3,7	3,9
Overload (long-term)		%	1 hour in a 6 hours period 110% rated load							
Overload per 20 sec.		%	300							
Stator Winding Resistance (20°C)	Ω		0,0042							
Rotor Winding Resistance (20°C)	Ω		7,367							
Exciter Resistance (20 °C)	Ω		Rotor : 0,317				Stator : 8,85			
Heat dissipation at f.l.cl.H	W		35340	32882	34723	33887	29678	28720	29332	28620
Telephone Interference			FHT < 2%				TIF < 40			
Radio interference			EN50081-1, EN50082-1, VDE0875K. For others standards apply to factory							
Waveform Distors.(THD) at f. load	LL/LN %		2,1 / 2,1							
Waveform Distors.(THD) at no load	LL/LN %		2,4 / 2,4							
<b>Mechanical characteristics</b>										
Protection			IP 21 (other protection on request )							
DE bearing			6322							
NDE bearing			6318.2RS							
Weight of wound stator assembly	kg		641							
Weight of wound rotor assembly	kg		386,7							
Weight of complete generator	kg		1586							
Maximun overspeed	rpm		2250							
Unbalanced magnetic pull at f.l.cl.F	kN/mm		6,8							
Cooling air requirement	m <sup>3</sup> /min		54				64,8			
Inertia Constant (H)	sec.		0,172				0,207			
Noise level at 1m/7m	dB(A)		94 / 82				98 / 88			

All technical data are to be considered as a reference and they can be modified without any notice.

This document is a propriety of Mecc Alte S.p.A.. All rights reserved.



**GENERATOR TYPE ECO 40-2L/4**

**50 Hz**

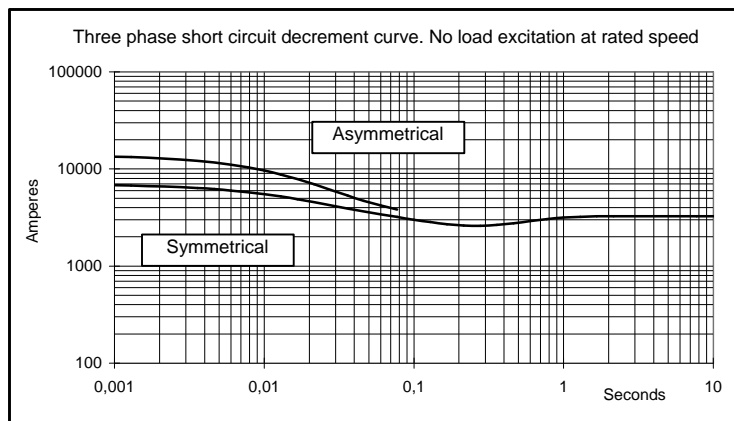
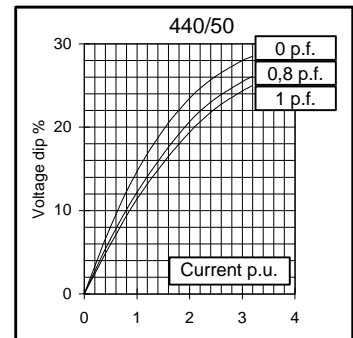
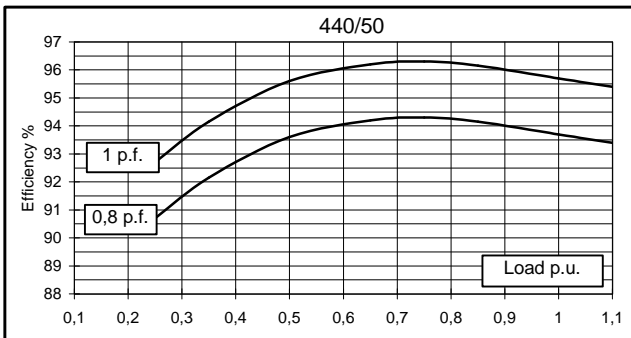
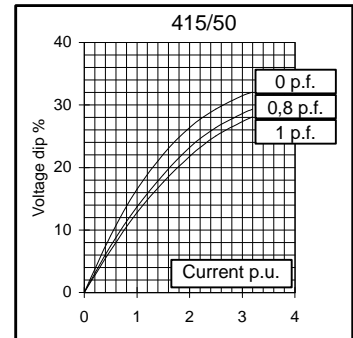
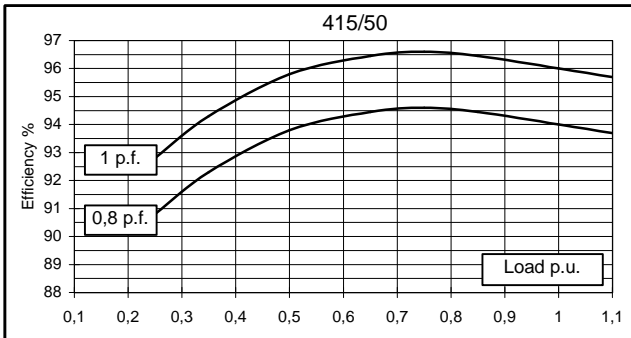
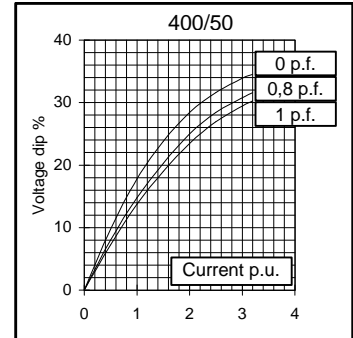
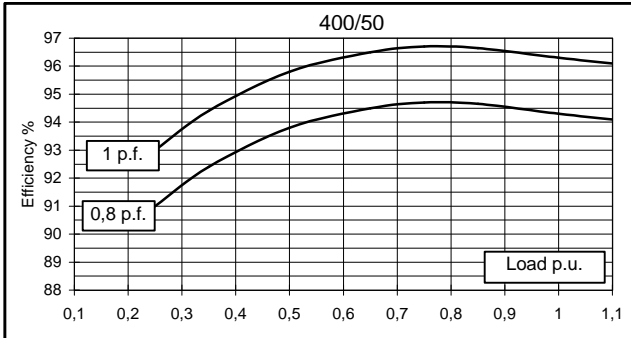
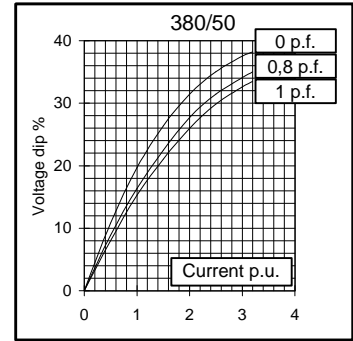
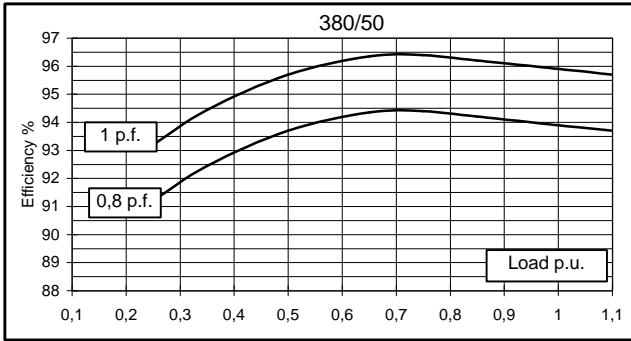

This document is a propriety of Mecc Alte S.p.A.. All rights reserved.



GENERATOR TYPE ECO 40-2L/4

60 Hz

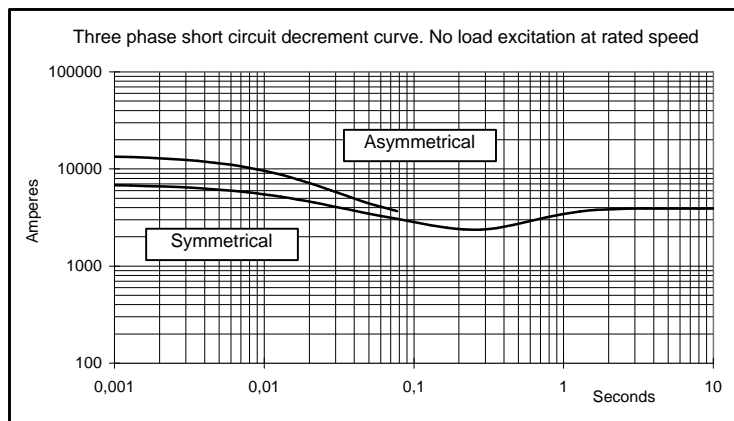
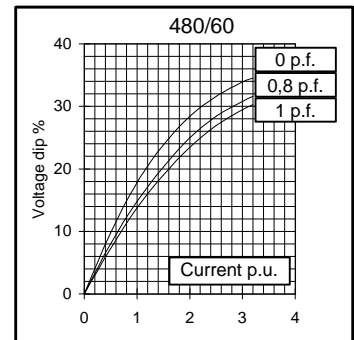
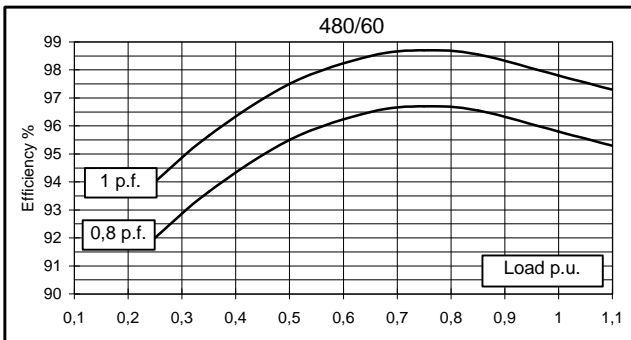
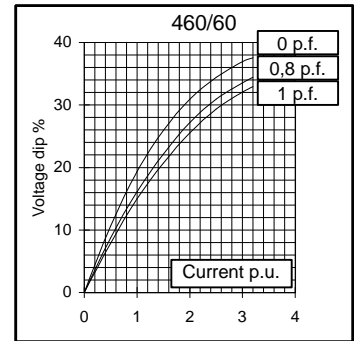
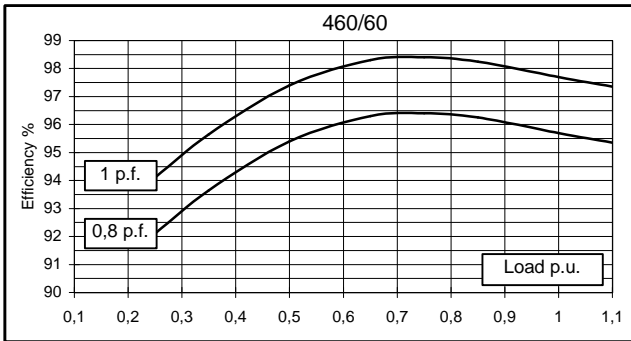
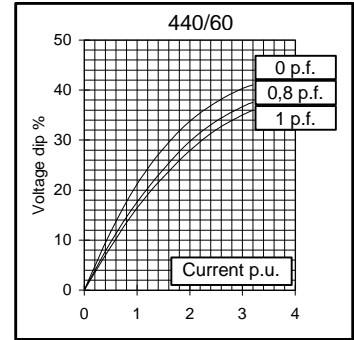
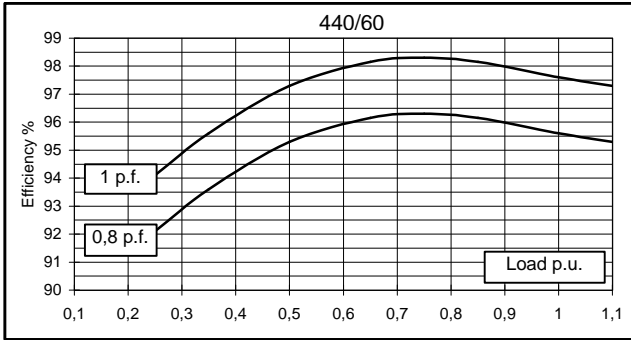
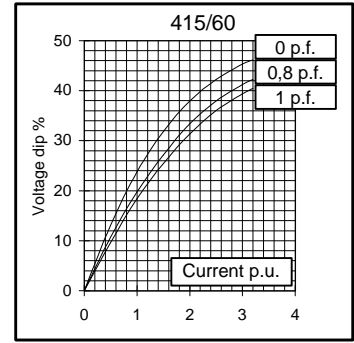
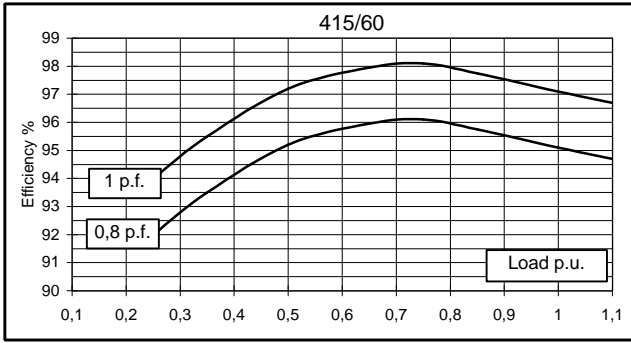

This document is a propriety of Mecc Alte S.p.A.. All rights reserved.

## TWO BEARING MOMENTS OF INERTIA

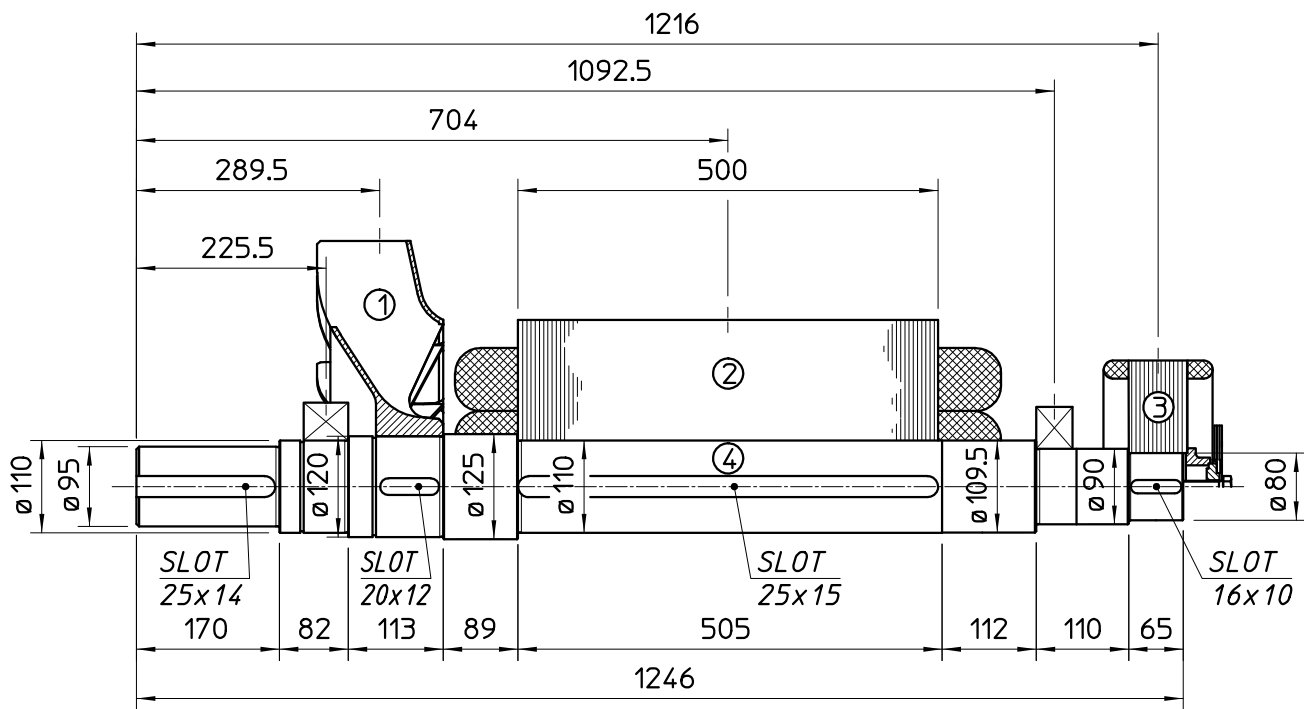

**RAD Diesel**

021-58437

COMPONENT	WEIGHT kg	J kgm <sup>2</sup>
1 FAN	16	0.550
2 MAIN ROTOR	386.7	8.234
3 EX. ROTOR	35	0.562
4 SHAFT	87.3	0.127
TOTAL	525	9.473

## TWO BEARING DIMENSIONS

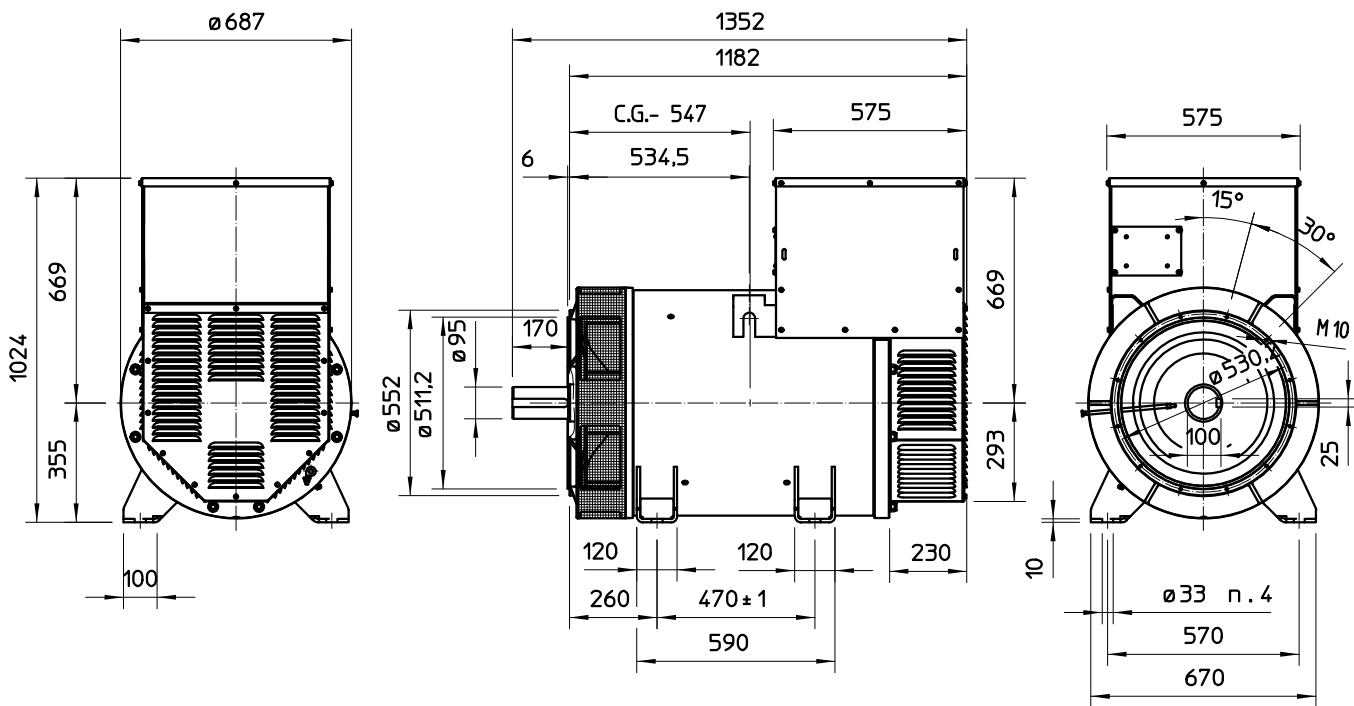

C.G.= GRAVITY CENTER

# SINGLE BEARING MOMENTS OF INERTIA

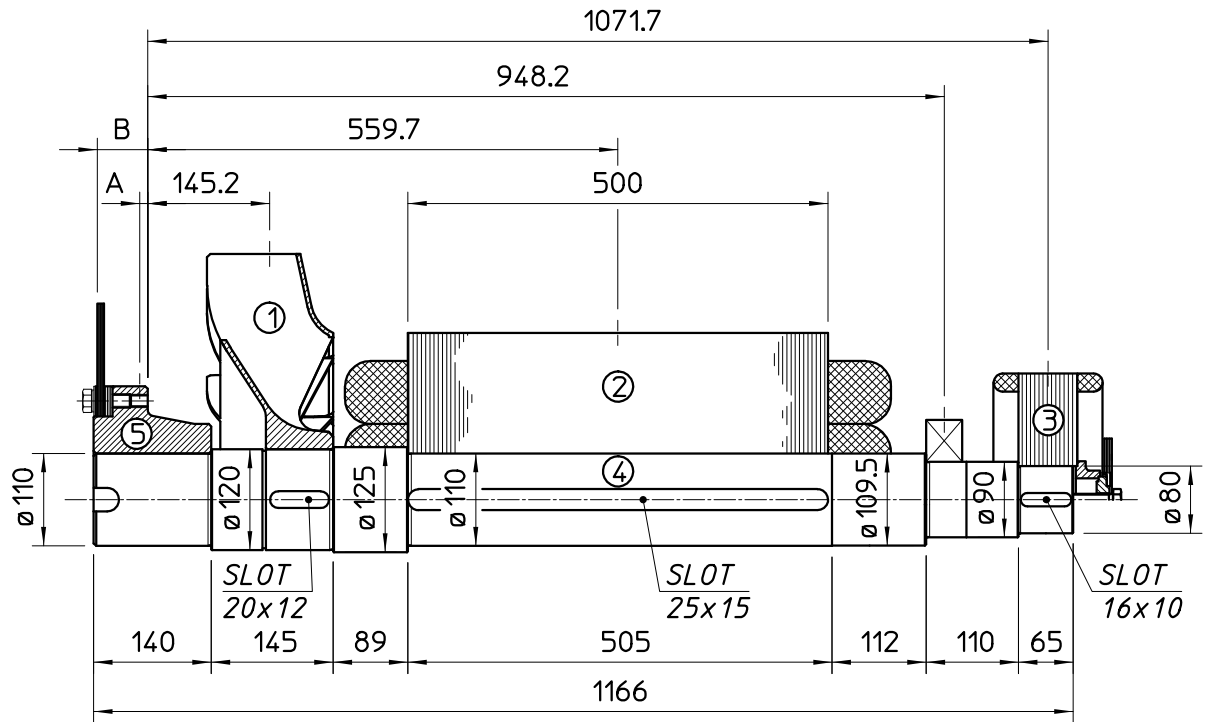

COMPONENT	WEIGHT kg	J kgm <sup>2</sup>
1 FAN	16	0.550
2 MAIN ROTOR	386.7	8.234
3 EX. ROTOR	35	0.562
4 SHAFT	85	0.124
TOTAL	522.7	9.47

SAE No	SHAFTS COUPLING FLEX PLATE			
	A	B	WEIGHT kg	J kgm <sup>2</sup>
14	9,6	60	41,4	0,511
18	6,6	50	45,1	0,858

# SINGLE BEARING DIMENSIONS

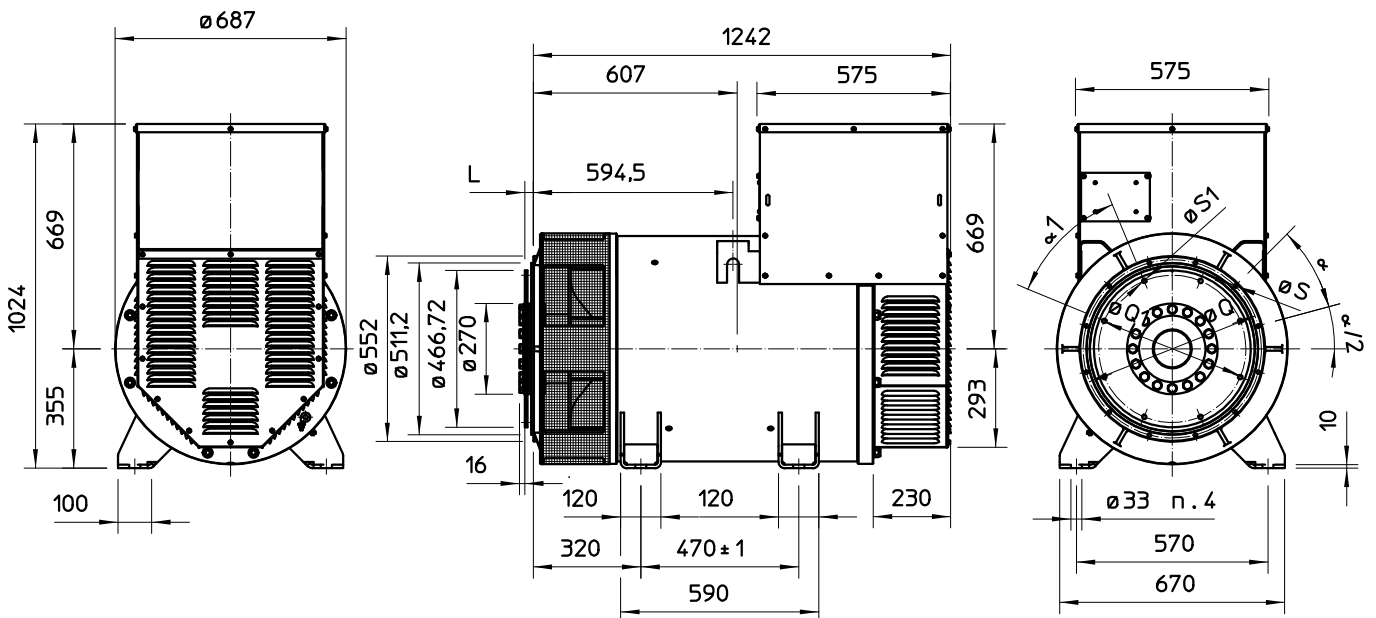

**RAD Diesel**

021-58437

C.G.= GRAVITY CENTER

SAE N.	DISC COUPLING					
	L	d	Q1	N. FORI	S1	Q1
14	25,4	466,72	438,15	8	14	45°
18	15,7	571,5	542,92	6	17	60°

SAE N.	FLANGE					
	O	P	Q	N. FORI	S	Q
1	552	511,2	530,2	12	11	15°
1/2	648	584,2	619,1	12	14	15°
0	711	647,7	679,5	16	14	11°15'
00	883	787,4	850,9	16	14	11°15'